

ALUSPACE

INTERNAL HINGED DOORS

Assembly Instructions

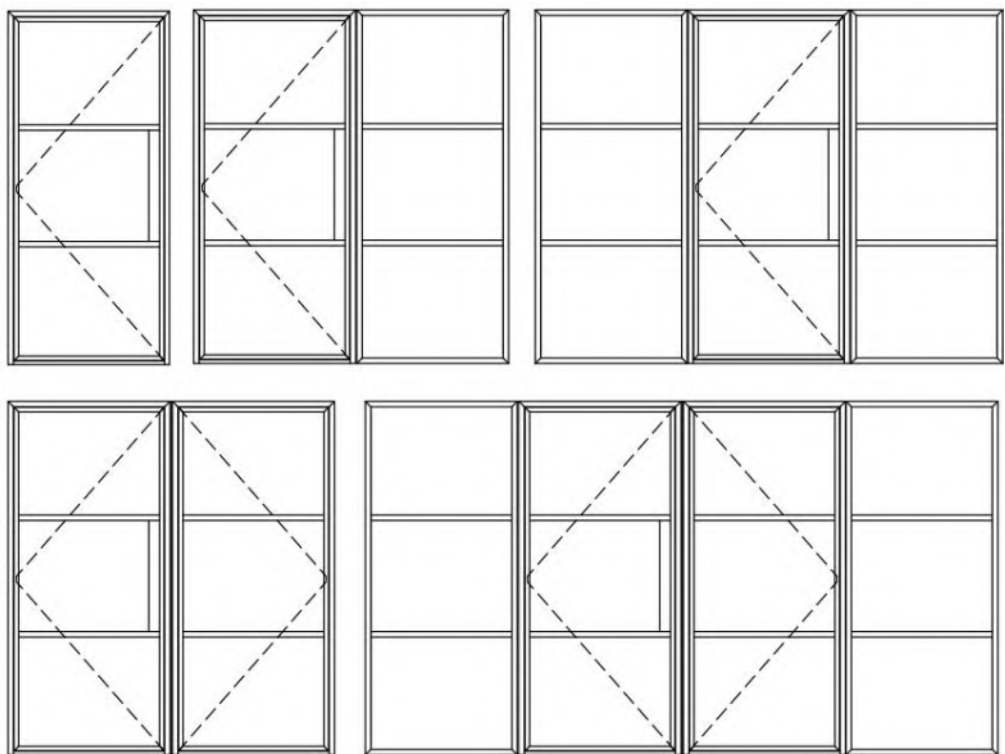

About your Aluspace internal doors

All Vufold Aluspace doors, frames, fanlight and sidelights, powder coating finish, single glazed units and hardware components are guaranteed for a full 10 years against the occurrence of manufacturing faults, all subject to correct installation, regular maintenance, and care in use as detailed below.

Powder Coating finish and maintenance

All our Aluspace door sets are supplied fully powder coated providing a high quality and durable finish, unless otherwise specified.

Our standard colour is Jet black – RAL 9005 Matt finish. If you have selected an alternative custom colour option and require the colour and RAL code, please contact a Vufold team member and they will provide this for you.

To maintain the powder-coated finish, wash regularly with soapy water and then dry off with a soft lint-free cloth.

We cannot accept any claims for damages, including scratches to the powder coating and aluminium reported 72 hours following delivery and / or after installation has commenced.

Installation

Our ready-to-assemble internal Aluspace doors are supplied with all the essential items and virtually everything pre-machined. This design allows for simple on-site assembly by a competent DIYer or experienced trades person(s).

All glass will be supplied loose and will require installation by a competent trades person experience with installing glass into doors and windows.

Important: For doors with sidelights only; if you intend on installing or have already installed under floor heating, please ensure that you have the heating pipe or mat location plan, as the sidelights require fixing down into the floor. If the current fixings are not suitable due to their length, please use an alternative fixing (not supplied) to ensure the sidelight is securely fixed down.

Importantly; the frame needs to be installed perfectly square and level on all planes into the opening and is designed to be installed on top of the finished floor level. If installing onto a sub floor, which will then have flooring on top of it, you will need to install the frame allowing of the thickness for the flooring or floor covering.

All our Aluspace internal door sets have been pre-assembled in our factory. They are installed into a steel framed testing rig where they are fully operated, including checking the doors open and close smoothly.

Single glazed units

Loose glass should never be placed directly onto hard floors such as concrete, but should be placed on cardboard, sheeting or wooden batons, on edge rather than flat. The glass should be stored on its edge and at a 3 – 6 degree angle. Glass should not be stored horizontally or on top of each other and should not come into contact with anything harder than itself.

Tempered glass means it has been toughened to be up to five times stronger than normal glass. It is unusual to break such strong glass, but sharp objects hitting the glass at certain points can cause breakage. Tempered glass is also known as safety glass. This means that if it breaks it will shatter into smaller fragments which are less likely to cause injury, unlike non-tempered glass which breaks into large, sharp fragments.

The glass must be inspected before being fitted to the door(s) and / or sidelight(s). We cannot accept any claims for scratched or damaged glass after 72 hours following delivery, and / or after installation has commenced.

Visual distortions caused by reflections in toughened glass are a natural phenomenon and not a fault.

Toughened, glass is acceptable if bubbles or blisters, fine scratched no more than 2.5cm long and / or minute particles or neither obtrusive nor bunched. The glass used is a processed glass therefore certain blemishes are unavoidable.

About your Aluspace internal doors (Cont)

For carrying out a glass inspection, stand at least 3 metres away from the glazing, view at a 90-degree angle and look directly through the glass. The glass must be viewed in natural daylight but not with the sun directly on it. Any moisture must be removed from the surface of the glass before inspecting.

Glass must be regularly maintained and cleaned. This can be done using a mild solution such as washing-up liquid diluted in water. Do not use abrasive cleaning solutions as this may cause scratching.

Hardware components

The hardware in your internal Aluspace door set can deteriorate from everyday use. That's why regular maintenance of your door hardware is important.

We require that the below minimum maintenance is carried out as often as necessary to prevent deterioration. As a guideline, we recommend that this maintenance is done every six months otherwise your guarantee will not be valid.

Hinges and bolts

Using a microfibre cloth, wipe down the visible surfaces with warm soapy water and then rinse off by wiping with a clean, damp cloth. Applying a thin film of light machine oil or silicone spray, wiping with a dry cloth to remove any excess, will help to maintain the original lustre of the metal finish. Be careful not to get these liquids on the aluminium as this can cause staining.

The bolts should be maintained using silicone spray by directing the nozzle into the applicable areas. Always hold a cloth directly under the nozzle to prevent any over spray or liquid running onto the aluminium.

Door latch and handles

Important: The magnetic latch will remain in the body of the lock until the door is closed and will automatically engage once it is aligned with the receiver plate. Pulling the handle lever down will then retract the magnetic latch.

All moving parts should be lubricated using a silicone spray.

The handles should be regularly cleaned with a soft damp microfibre cloth to remove any dust or grime taking care not to scratch the surface.

It is important that if you feel any resistance when operating the handle, you do not continue to operate the doors as this may eventually cause damages and will invalidate your guarantee. Please contact a member of our customer service team so we can assist you further.

Introduction to quick assembly

Aluspace doors come pre-built, hinged to the frame and ready for installation.

Securing Assembled Door Sets:

Temporarily secure the doors in the opening using air wedges or packers.

Once the frame is secure, open the doors and fix the frame directly into the opening.

Ensure the frame is perfectly plumb, square, and level on all planes, and free from twisting before permanently fixing it into the stud / brickwork opening.

Installing Fanlights & Sidelights:

Fix the fanlight and sidelights to the outer frame by screwing through the frame into the coupler, pre-fitted to the fanlight and sidelight. The assembled frame, fanlight and sidelight can then be fixed into the opening.

Full and detailed installation instructions are contained within this Instruction booklet

Contents

IMPORTANT: Please check the contents of the packages to ensure that all parts are present and in good condition before booking your installation

Door, frame, fanlight and sidelight components	Single Door Qty	French Door Qty	Single Sidelight Qty	Double Sidelight Qty
Frame (head, left & right jambs)	1	1		
Door and glass (unglazed, hinged to frame)	1/(3pcs glass)	2/(6 pcs glass)		
Door glazing bead (temp-fitted)	12	24		
Frame cover strips	1	1		
Sidelight and glass (unglazed)			1/(3 pcs glass)	2/(6 pcs glass)
Sidelight coupler (pre-fitted)			1	2
Sidelight glazing bead (temp-fitted)			12	24
Fanlight and glass (unglazed)	1/(1pcs glass)	1/(2pcs glass)		
Fanlight glazing bead	4	8		
Wedge gasket roll	1	1	1	1
Retaining gasket	1	1	1	1
9mm glazing packers (bag)				
Self tapping screws (taped to frame) (bag)				
Hardware components (pre-fitted)	Qty			Qty
Door handle pair	1	Hinges (single door)		3
Magnetic door latch	1	Hinges (French doors)		6
Latch plate	1	Hinge clamp screws		5 (per hinge)
Finger flush bolts (French doors only)	2	Hinge final fix screws		1 (per hinge)
Finger flush bolt keep (French doors only- loose)	1			
Fixing kit contents	Single Door Qty	French Door Qty	Single Sidelight Qty	Double Sidelight Qty
70mm direct frame fixings	12	15	14	19
6.5mm SDS dill bit	1	1		
6.5mm masonry drill bit	1	1		
TX30 1/4 hex insert bit	1	1		
PZ2 1/4 hex insert bit			1	1

Preparing the site

When preparing the site, please prepare the brickwork / stud wall opening to be 10mm more in height and in width than the outside assembled frame size.

Brick / stud work opening = Frame width + 10mm

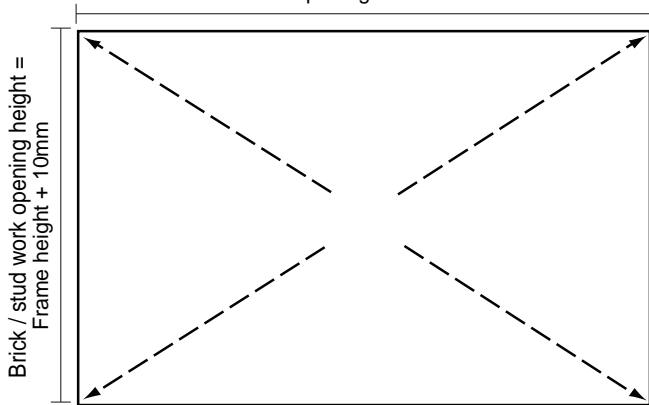

It is essential that all the internal surfaces of the brick / stud work are level before installation. Please ensure that all dimensions are correct for installation before proceeding, as the door set must be installed square and level into the opening.

The brick / stud wall opening is classed as a finished opening size so it is important you have allowed for any additional plaster works or architraves.

Finishing around the frame is a personal preference and should be decided between yourself and the installer.

VERY IMPORTANT. The frame and doors are designed to be installed **ON TOP OF THE FLOORING** or floor covering. If installing onto a sub floor, which will then have flooring on top of it, you will need to install the frame allowing for the thickness of the flooring / covering.

Opening options

Our Aluspace internal doors are not reversible and therefore can only be installed in the opening direction specified on your order, eg left or right.

Opening direction

The direction the doors open towards will be determined by which way round you install the outer frame into the opening. The same frame can be installed to have the doors opening towards or away from you by rotating the assembled outer frame 180 degrees.

Example shows jamb position & opening direction on French Doors

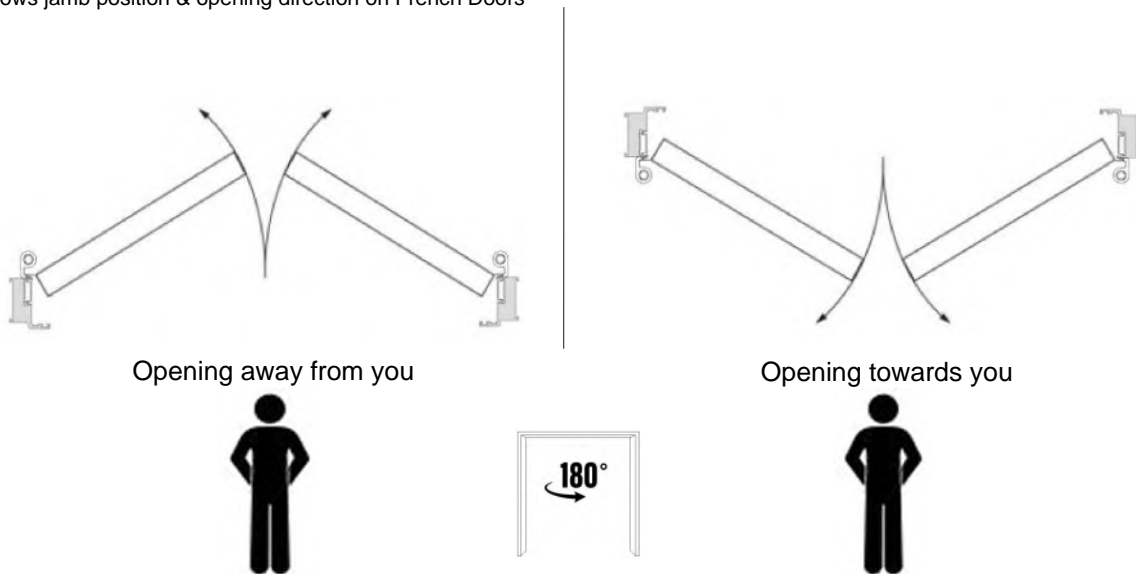

Opening options (Cont)

Door configuration

Which side you have the Access door is determined at the point of ordering and cannot be reversed.

Single door

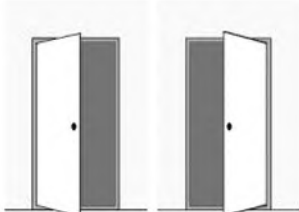

Left opening Right opening

Single door with single sidelight

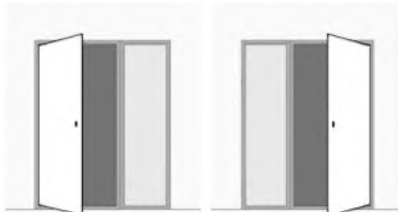

Left opening Right opening

Single door with double sidelight

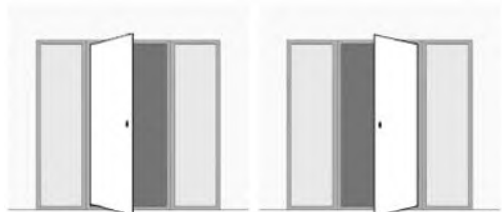

Left opening Right opening

French door

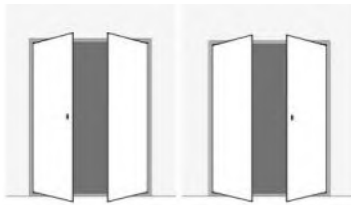

Left opening Right opening

French door with double sidelights

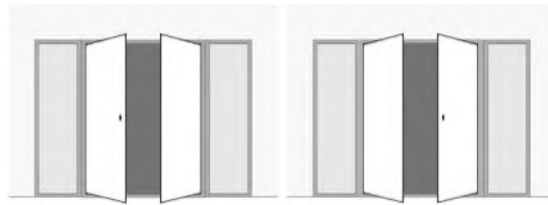

Left opening Right opening

Single and French doors without fanlights and sidelights

All doors come with the doors already hinged to the built-up outer frame.

Important: To ensure the frame does not get damaged or twisted, care should be taken when handling the doors before they are securely fixed into the opening.

A timber section will be affixed to the bottom of the frame to ensure stability during transportation, which should be removed before installation.



Lift the frame and door into the opening and temporarily secure in place using air wedges and/or packers, ensuring the frame is perfectly square and level on all planes. Once the frame is secured in place you can now open the doors ensuring you support the weight of the doors to prevent the frame from moving. Re-check the levels and then direct fix the frame into the opening. Please follow the below instructions 'Installing the assembled door frame'.

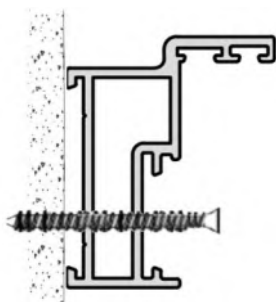

Fixing point through door frame

Ensure a second person is always on hand to help steady the door and frame during these installations.

Fitting fanlights and sidelights

It is recommended that quick grip clamps are used during this process.

Your fanlight and sidelight will be supplied unglazed to allow access to the fixing points. The securing couplers will be fitted pre-fitted and require connecting to the outer frame.

Carefully open the door(s) to 90 degrees and support the weight at the bottom to avoid distorting or damaging the frame.

Starting with the fanlight first, locate the pre-machined holes in the frame head. Fix through the frame head into the top light coupler, which should already be pre-fitted to the top light, using the self-tapping screws and PZ2 bit provided. Be extremely careful not to twist or distort the frame.

Next, locate the pre-machined holes in the frame jambs. Fix through the frame jambs into the sidelight coupler, which should already be pre-fitted to the sidelight, using the self-tapping screws and PZ2 bit provided. For double sidelights, repeat the process on the opposite side.

The fanlight will need securing to the sidelight coupler using the same method.

Ensure the fanlight and sidelight are securely fixed to the frame and are straight and level. The assembled frame, top light, and sidelight can now be installed into the opening.

IMPORTANT: It is essential that once the fanlight and sidelight(s) have been fitted, the frame is handled with great care and not twisted or lifted unevenly.

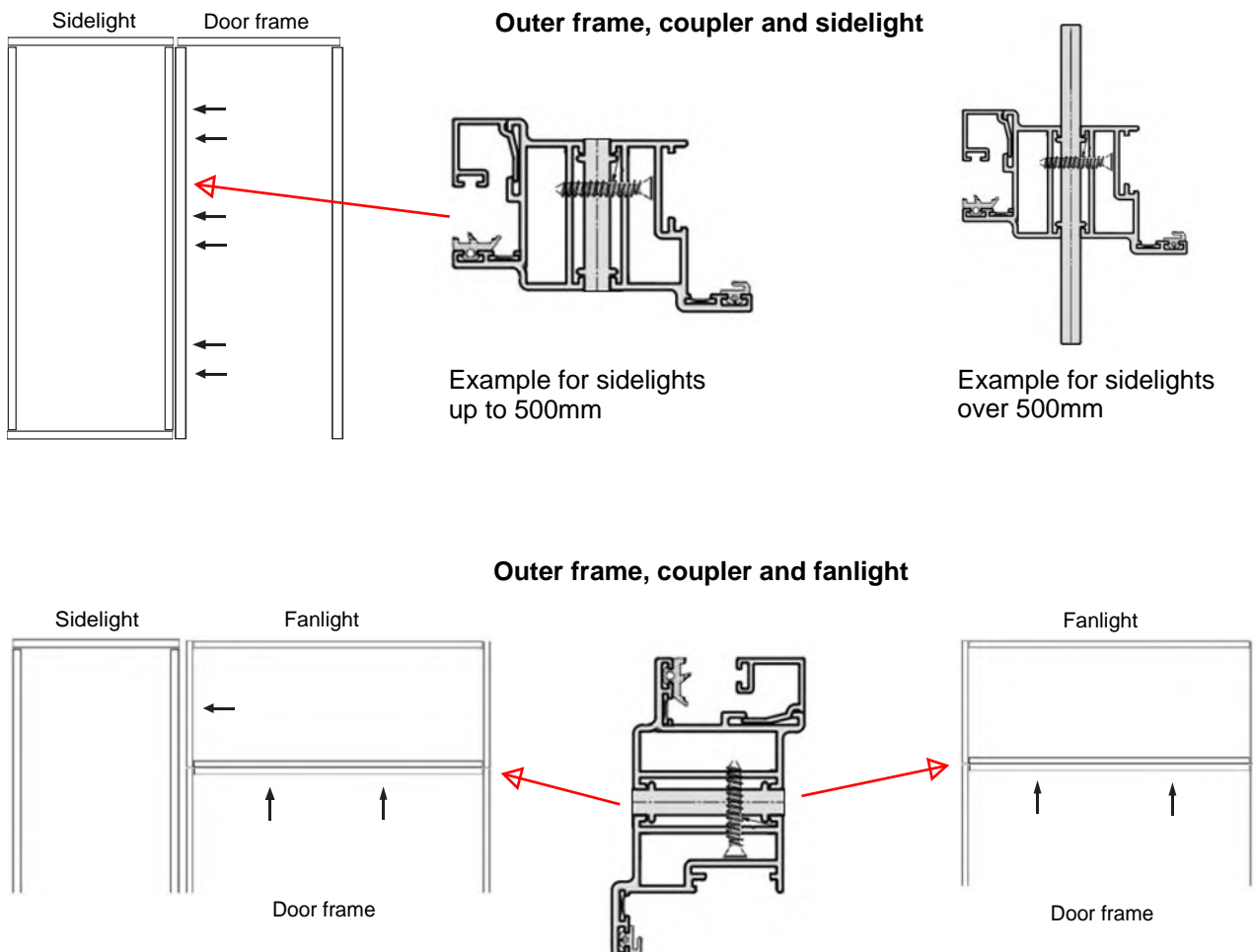

Installing the assembled door frame

Proceed to install the assembled frame.
It is critical that the frame is fitted square and level.

Ensure the frame is installed straight and square.
 Use shims / packers between the frame and the opening.

The height (H) must be the same across the whole width of the opening.

The diagonals must be the same.
It is very important the frame jambs are level. Place a spirit level on the face and sides of each jamb and check before proceeding.

Secure the assembled frame into the brickwork / stud wall opening using the direct frame fixings supplied (unless the construction of your building requires more appropriate fixings to suit the individual dwelling).

Frame fixing points will vary depending on the construction of the opening. If needed screw into a good hardwood timber baton secured into the cavity.

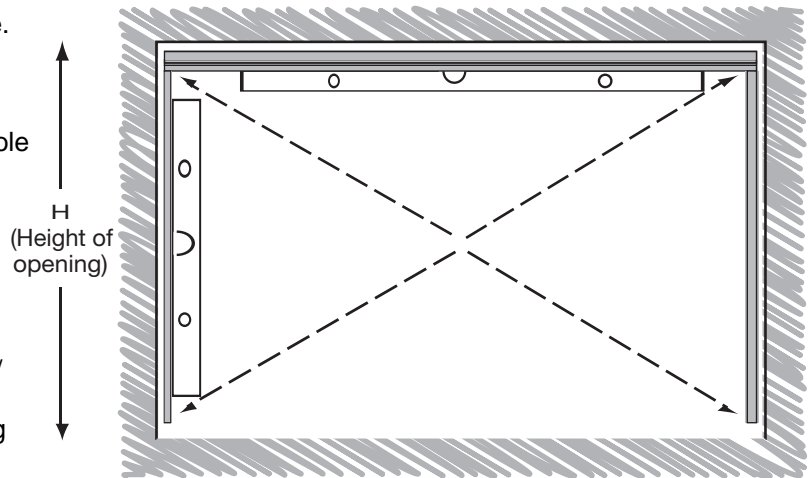

Important: When drilling and fixing the frame into the opening, take extra care not to bend the aluminium frame.

Before drilling for the sidelight fixing, please ensure that there are no under floor heating pipes or mats in the intended location. An alternative fixing (not supplied) may be required. Please ensure the sidelight is securely fixed down.

Use the direct frame fixings as follows;

- Use the 6.5mm HSS drill supplied to drill the holes in the frame.
- Use the 6.5mm SDS masonry drill supplied to drill into the brickwork.
- Use a Torx T30 bit to screw in the direct frame fixings.

Very important: Carefully check the frame is tightly fixed together and is square. Diagonals of the frame must be equal. Do not proceed with installation if the frame is not square.

Please see below diagrams for recommended fixing positions

→ Frame fixing points

Single door

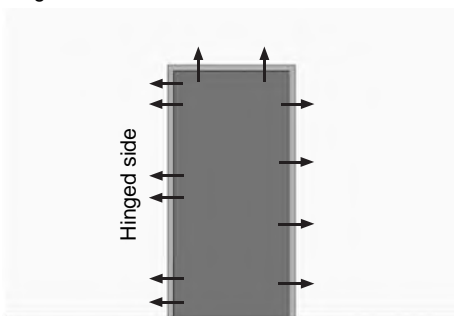

Single door and single sidelight

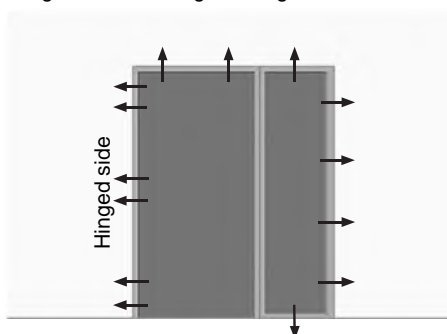

Single door and double sidelights

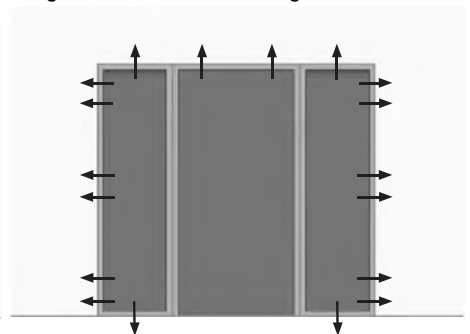

Installing the assembled door frame (cont)

French door

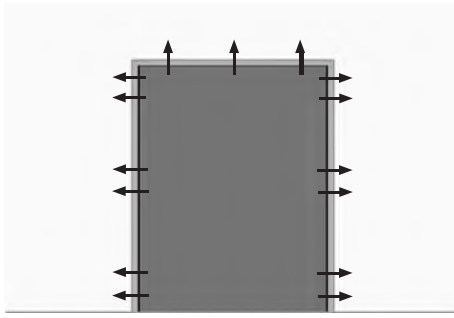

French door and double sidelights

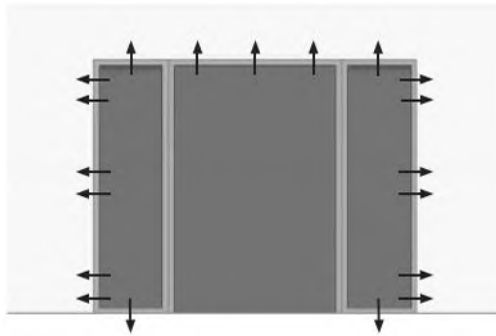

Fixing point through sidelights



Fixing point through door frame

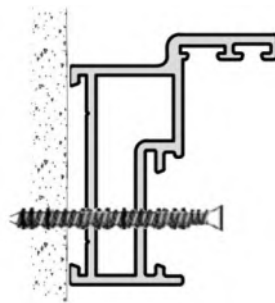

Fixing point through the fanlight

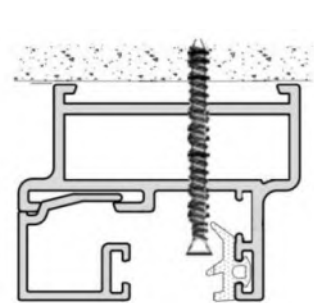

Glazing the doors

Ensure the doors are in the closed position.

Remove the glazing beads from the doors taking note of the location they have been removed from.

Locate the retaining glazing gasket (one length per door/sidelight).

Fit the gasket to the door according to the diagram provided.

Position the gasket against the frame side of each door.

Cut the gasket to size, leaving it slightly oversized to account for any shrinkage.

Please note, the wedge and retaining gasket have been supplied with extra material to ensure you have enough to fully seal your door and sidelights.

The glazing will require 'toe and heeling' using the 9mm glazing packers provided, as per the below diagram. The 'toe and heeling' process will allow for the doors to be pulled square for only minor frame discrepancies.

Fit the glass into the door and pack accordingly.

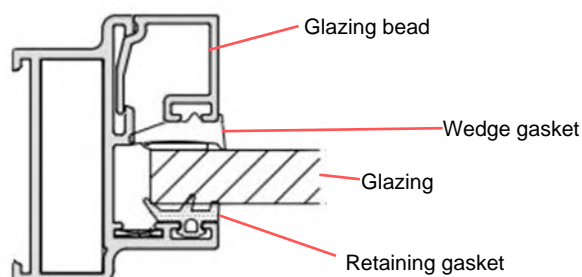

Glazing the doors (cont)

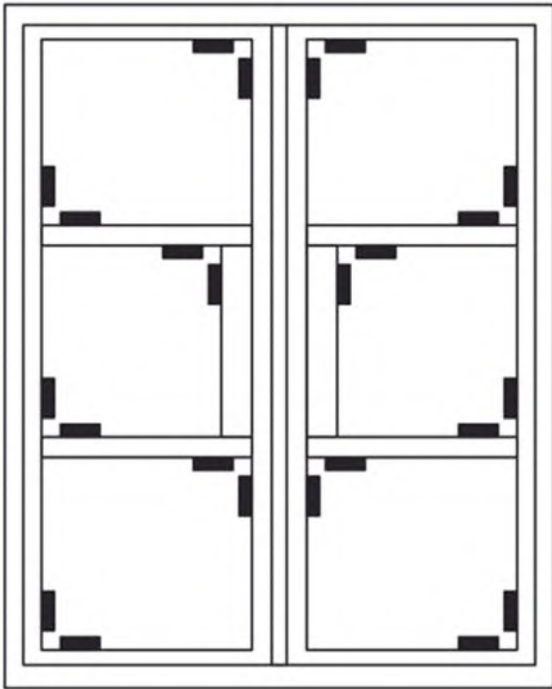

Once the glass has been fully supported and the 'toe and heeling' completed, place the beading in its original location, start at the top, then the bottom and then finish with the side sections.

Now fit the wedge gasket between the glass and the bead. The wedge gasket will require cutting to size before fitting.

The back section of the wedge gasket will require trimming to allow for a flush fitting where the glazing packers are located. As per the below diagram.



Glazing the fanlight(s) and sidelight(s)

Once you have fully installed the doors and frame into the opening perfectly plumb, square and level on all planes, you can now install the retaining gasket, glass, beading and wedge gasket into the fanlight and / or sidelight(s) using the same glazing method taken in the previous steps when glazing the doors.

The fanlight and sidelight(s) do not require 'toe and heeling' and will just require sitting on 2 supporting glazing packers at the bottom per piece of glass.

Flush bolts and keeps (French doors only)

The finger / flush bolts have been pre-fitted to the edge of slave door.

Once you are 100% happy the doors are correctly fitted, aligned and operating smoothly, fit the bolt keep and black spacer to the frame head using the self-tapping screws provided.

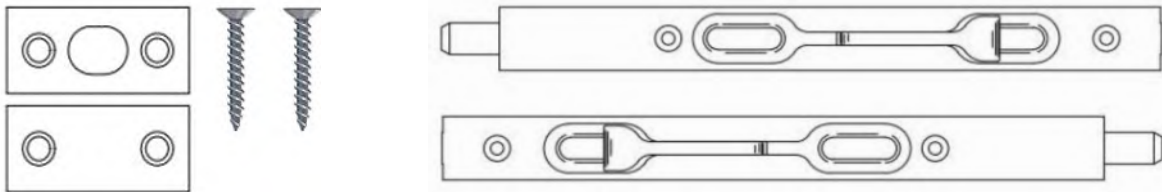

For the bottom flush bolt, it is recommended that you drill an 8 – 10mm diameter hole in the floor for the bottom finger / flush bolt to locate into.

Using a bottom flush bolt provides greater rigidity when the doors are operated and closed, and it is our recommendation this is used. If however, it is preferred NOT to drill a hole into the flooring, please note well that the doors will be less rigid and it will also cause the doors to sit slightly out of line.

Close the slave door and engage the top and bottom finger / flush bolts, now close the access door. Making sure the doors are full aligned, mark the floor as to where the bottom bolt would strike the flooring, open the access door and disengage the bolts.

Cover trims

Finally cut and fit the plastic cover trim to the outer frame jambs and head, covering the frame fixings.

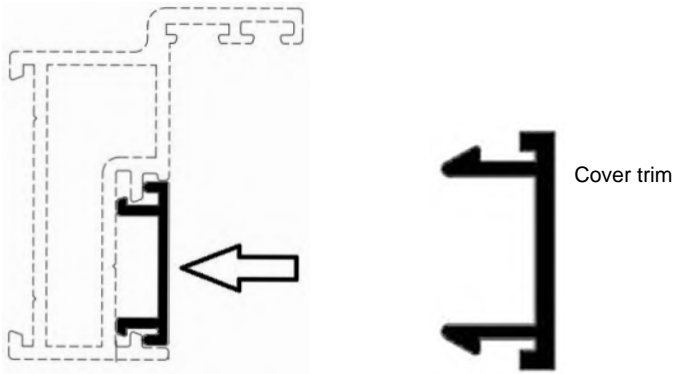

Operational checks

IMPORTANT: The handle does not activate the door latch. The latch is magnetic and will only operate when closing the door into the frame, attracted by the magnetic attraction located in the latch receiver plate. The only way to activate the door latch when the door is open is by offering something with magnetic attraction to it. You do not need to pull the handle up or down to activate the latch. If, when pushing the door closed, the magnetic latch is not engaging, this usually indicates a misalignment of the frame. Please recheck the frame levels and ensure that the spacing is even all the way down the door. Also, check that the door is square, and the glass has been balanced correctly.

Should you experience any operational issues relating to the magnetic latch:

Check The Magnetic Attraction: Place a screwdriver against the latch, it should pull out.

Verify The Magnet Position: Ensure the magnet is correctly fitted into the latch body and check if the magnet needs to be reversed.

Check The Spacing: Ensure the spacing is even on the closing/latch edge of the door at the top, middle, and bottom. Insert packers behind the middle section of the outer frame jambs to bring the latch and latch receiver closer together.